

Photoelectrics

Type EF 1801

Fiber Optic Sensor

CARLO GAVAZZI



- Range: Fiber dependent, typ. 100 mm
- Adjustable sensitivity
- Modulated, red light
- Rated operational voltage: 10 to 40 VDC
- Output: DC 200 mA NPN or PNP
- Make and break switching function, LED indication
- Heavy duty M18 metal housing, IP 67
- Cable and plug versions
- For 2.2 mm fiber cable with 1 mm core
- MB 18 A for DIN-rail mounting (see Accessories)



Product Description

Used in through-beam, retro-reflective or diffuse-reflective applications depending upon how the additional fibers are mounted. Easily adjustable sensitivity with 270° potentiometer. LED indication for out-

put ON. Short M18 metal housing for heavy duty applications. The fiber allows positioning and mounting in tight spaces with the photoelectric sensor itself mounted in a more convenient location.

Ordering Key

EF 18 01 PPA S - 1

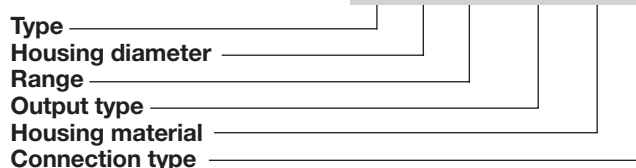

Type Selection

Housing diameter	Rated operating dist. (S _n)	Ordering no. NPN/cable Make & break swit.	Ordering no. NPN/plug Make & break swit.	Ordering no. PNP/cable Make & break swit.	Ordering no. PNP/plug Make & break swit.
M18	Fiber depend.	EF 1801 NPAS	EF 1801 NPAS-1	EF 1801 PPAS	EF 1801 PPAS-1

Specifications

Rated operating dist. (S_n)	Fiber dependent	Operating frequency (f)	120 Hz, light/dark ratio 1:2
Temperature drift	0.4%/K	Response time	
Hysteresis (H) (Differential travel)	3 to 20%	OFF-ON (t _{ON})	≤ 3.2 ms
Rated operational volt. (U_B)	10 to 40 VDC (ripple included)	ON-OFF (t _{OFF})	≤ 5 ms
Ripple (U_{rpp})	≤ 10%	Power ON delay (t_v)	Typ. 100 ms
Output current		Indication	Output ON
Continuous (I _a)	≤ 200 mA	Environment	LED, yellow
Short-time (I)	200 mA, max. load capacity 100 nF	Overvoltage category	III (IEC 60664/664A; 60947-1)
No load supply current (I_o)	≤ 20 mA,	Pollution degree	3 (IEC 60664/664A; 60947-1)
Min. load current (I_m)	0.5 mA	Degree of protection	IP 67 (IEC 60529; 60947-1)
OFF-state current (I_r)	≤ 100 μA	Temperature	
Voltage drop (U_d)	≤ 2.5 V	Operating	-20° to +60°C (-4° to 140°F)
Protection	Reverse polarity, short circuit, transients	Storage	-30° to +70°C (-22° to 158°F)
Transient voltage	Max. 1 kV/0.5 J	Vibration	10 to 150 Hz, 0.5 mm/7.5 g (IEC 60068-2-6)
Sensitivity	Adjustable, 270° turn potentiometer,	Shock	2 x 1 m & 100 x 0.5 m (IEC 60068-2-32)
Light source	660 nm	Dielectric voltage	500 VAC (rms)
Light type	Red, modulated, synchronized	Housing material	
		Body	Nickel-plated brass
		Front	TPE/POM, black
		Cable end	Polyester, black
		Nuts	Nickel-plated brass



Specifications (cont.)

Connection Cable	Grey, 2 m, oilproof PVC, 4 x 0.35 mm ² Note: Other cable lengths on request
Plug (-1) Cables for plug (-1)	M12 CONH1A-. serie
Weight Cable version Plug version	115 g 40 g
CE-marking	Yes

Dimensions

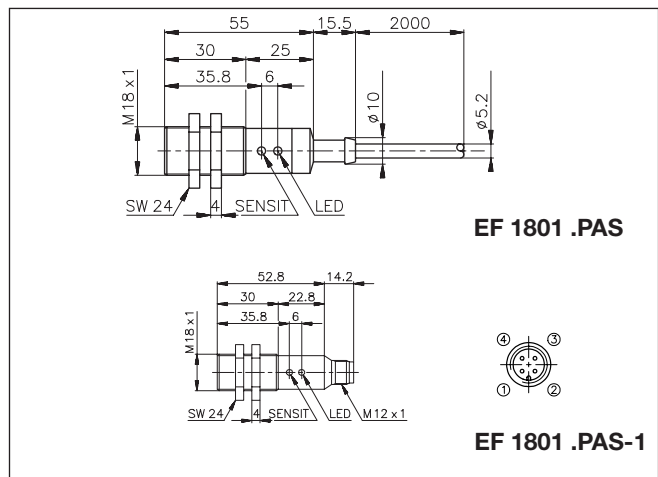

Operation Diagram

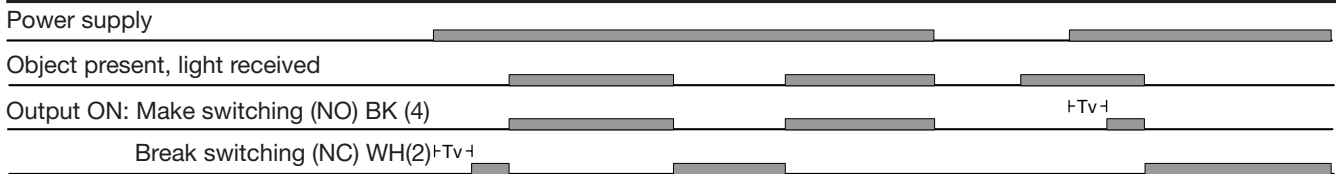

Truth Table

	Make switching		Break switching	
	No	Yes	No	Yes
Object present	No	Yes	No	Yes
DC types				
LED	OFF	ON	OFF	ON
Load	Non-active	Active	Active	Non-active
Output NPN	High	Low	Low	High
Output PNP	Low	High	High	Low

Wiring Diagrams

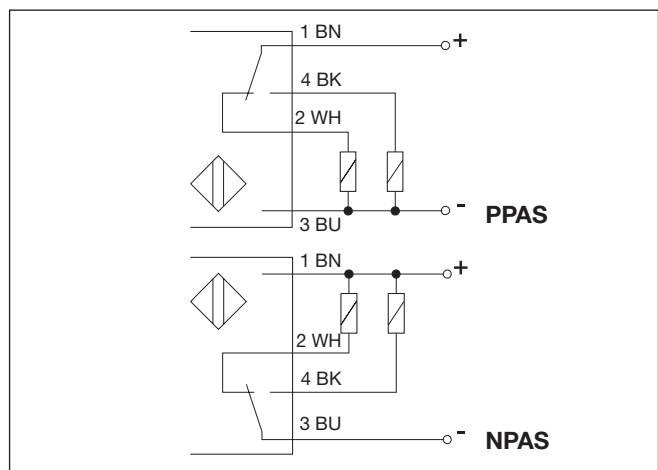

Accessories

- Fiber optics - call for further information
- Connector type CON.1A../CON.14NF.. serie

Please refer to "Accessories"

Delivery Contents

- Photoelectric switch: EF 1801....
- 2 nuts
- M18 mounting bracket MB 18A for direct surface or DIN-rail mounting
- Screw driver
- Fiber cutter
- **Packaging:** cardboard box

Installation Hints

When you insert the fibers:

- Push the spring-loaded clamp (1) with the enclosed screw driver towards the fiber entries (2). The fiber entries are now open for putting in the fibers.
- Put in the fibers. Be sure that the fibers pass the constriction near the bot-

tom of the hole. The constriction seals the junction (between fiber and photo element) against dust.

The sensing distance will be reduced if there is an air gap between the fiber and the photo element.

- Release the clamp to fix the fibers.

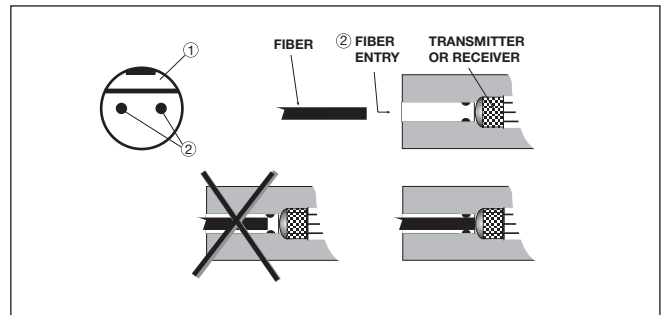

Installation Hints

To avoid interference from inductive voltage/current peaks, separate the prox. switch power cables from any other power cables, e.g. motor, contactor or solenoid cables

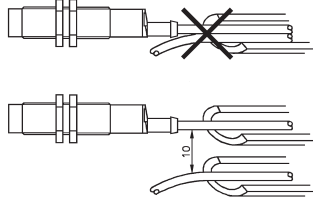

Relief of cable strain

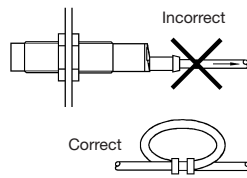

The cable should not be pulled

Protection of the sensing face

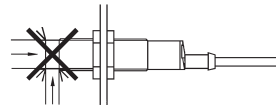

A proximity switch should not serve as mechanical stop

Switch mounted on mobile carrier

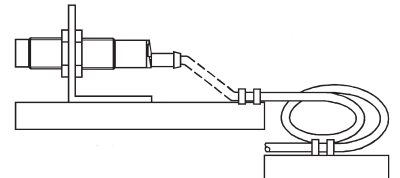

Any repetitive flexing of the cable should be avoided